



Lithionics Battery®

User Guide

NeverDie® Compact Series Battery

Models:

12V125A-G31-5CND-LR

12V125A-G31-5CND-LRB

12V125A-G31-5CND-RR

12V125A-G31-5CND-RRB



Notice of Copyright

NeverDie® Compact Battery User Guide Copyright © 2018 all rights reserved. No part of this document may be reproduced in any form without the express consent of Lithionics Battery, Clearwater, FL 33765 USA. Lithionics Battery reserves the right to revise this document and make periodic changes to the contents without obligation or organization of such changes and revisions.

Index

Index	2
Overview	2
Battery Specifications	3
Battery Installation	4
Battery Charging	5
LED Indicator	5
Battery Management System Definitions	6
Battery Operation	8
Advanced Battery Functions	9
Bluetooth Telemetry	10
Status Code Bit Values	11

Safety

- All electrical work should be performed in accordance with local and national electrical codes.
- Assume that voltage is present at the battery terminals, use insulated tools and gloves while working on the system.
- Always turn off equipment connected to the battery in addition to turning OFF the Power switch on the battery to isolate it from other electrical circuits, before performing any repairs or maintenance on the system.
- Always use proper wire sizes to connect the system to inverters, chargers or other equipment.
- Always use crimped connections to connect to the battery terminals.
- Read and follow the inverter, charger or other equipment manufacturers safety precautions prior to connecting the battery to that equipment.
- Always use charging equipment compatible with Lithium Iron Phosphate battery chemistry. See battery charging section below.

Overview

The NeverDie® Compact Battery is a lithium iron phosphate LiFePO₄ chemistry battery with an internal Battery Management System (BMS) technology called *NeverDie® Compact BMS*. The BMS monitors voltage, current and temperature of each individual cell inside the battery and protects the battery from potential damage by disconnecting the battery circuit when the monitored parameters go outside of the allowed limits. The BMS also transmits monitoring data over the optional integrated Bluetooth interface, allowing customers to check the battery data on their mobile phones or tablets.

Model Variants

- 12V125A-G31-5CND-LR - Lid Reset Button
- 12V125A-G31-5CND-LRB - Lid Reset Button w/BlueTooth
- 12V125A-G31-5CND-RR - Remote Reset Button
- 12V125A-G31-5CND-RRB - Remote Reset Button w/BlueTooth

Battery Specifications

Item	Description	
Model	12V125A-G31-5CND	
Nominal Voltage	12.8V	
Nominal Capacity	125Ah	
Internal Resistance	≤4mΩ	
Features	NeverDie® Reserve, High and Low Voltage Cutoff, High and Low Temperature Cutoff, Short Circuit Protection, Bluetooth App Support	
NOTE: Battery may <u>not</u> be connected in series to make 24 volts or higher.		
Charge		
Charging temperature range	32~113°F (0~45°C)	
Charge voltage	14.4±0.1V	
Recommended float charge voltage (for standby use)	13.5±0.1V	
Recommended charge current	≤50A	
Allowed max charge current	100A with starting temp of 77°F (25°C)	
Discharge		
Discharging temperature range	-4~131°F (-20~55°C)	
Output Voltage Range	10.4~14.6V	
Recommended discharge current	≤80A	
Max continuous discharge current	100A with starting temp of 77°F (25°C)	
Surge discharge current	<400A for 30s max with starting temp of 77°F (25°C)	
Pulse discharge current	<1000A for 1s max with starting temp of 77°F (25°C)	
Reserve cut-off voltage	12.0V±0.05V	
Discharge cut-off voltage	10.4±0.1V	
Mechanical Characteristics		
Dimensions	Length 12.5in (318mm)	
	Width 6.5in (165mm)	
	Height 8.46in (215mm)	
Mounting Orientation	Upright position only (terminals up)	
Weight	Approx. 33.4lbs (15.1Kg)	
Storage		
Storage Temperature & Humidity Range	< 1 Month	-4~95°F (-20~35°C), 45~75%RH
	< 3 Months	14~86°F (-10~30°C), 45~75%RH
	Recommended storage	59~95°F (15~35°C), 45%RH~75%RH
Long Term Storage	If the battery needs to be stored for > 3 months the voltage should be 13.2V (50%SoC) and stored at the recommended storage specifications shown above. <u>Additionally, the battery needs at least one charge & discharge cycle every six months.</u>	
Self-discharge rate	Residual capacity	≤3% per month; ≤15% per year
	Reversible capacity	≤1.5%per month; ≤8% per year

Battery Installation

Check the battery for visible damage including cracks, dents, deformation and other visible abnormalities. The top surface of the battery and terminal connections should be clean, free of dirt and corrosion, and dry.

Battery power should be turned off prior to the installation and for storage. Check the LED integrated into the Power button to make sure it is completely off. If the LED is on or blinking, press and hold the Power button for 3 seconds until LED turns off.

Lithium batteries do not release gas during normal use. There are no specific ventilation requirements for battery installation, although enough airflow should be provided to prevent excessive heat build-up.

The battery should be stored and installed in a clean, cool and dry place, keeping water, oil, and dirt away from the battery. If any of these materials can accumulate on the top surface of the battery, current leakage can occur, resulting in self-discharge and possible short circuits.

The orientation of the battery must be with the terminals facing up as shown. Sideways, and upside-down orientations are not permitted and will void the warranty.



The battery is equipped with two flat threaded terminals designed for a 5/16" or M8 size ring terminal lug and secured by included M8 bolts, flat washers and lock washers. When using flat washers, it is critical to place the ring terminal lug in direct contact with the top surface of the power terminal and then place the washers on top of the lug. Connect the positive and negative battery cables with correct polarity and double check the polarity of battery circuit to avoid potential equipment and battery damage.

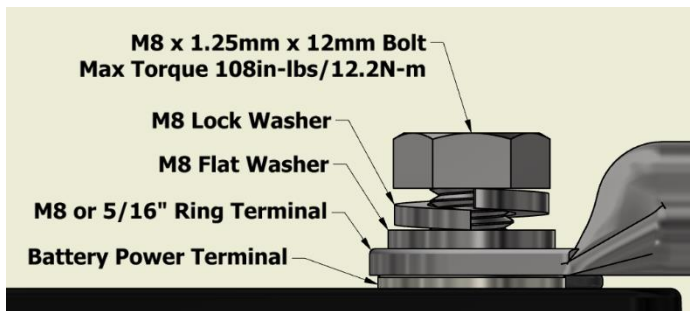

DO NOT place any washers between the battery power terminal and the ring terminal lug, as this could create a high resistance path and cause excessive heating of the connection which could then lead to permanent battery damage or fire.

If you must attach more than one lug to each terminal, make sure at least 1/4" or 6mm of thread is available to secure the connection. Additionally, the ring terminal lugs need to be "clocked" in such a way that they do not interfere with their flat conducting surfaces. Acquire and use longer M8x1.25mm bolts if necessary.

Tighten both M8 power terminal bolts to a maximum of 108in-lbs/12.2Nm to ensure there is good contact with the ring terminal lug.

CAUTION: Over-tightening the terminal bolts can damage the terminal. Loose terminal bolts can result in a high resistance connection which could then lead to permanent battery damage and/or fire.

The battery cables should be sized to handle the expected load. Refer to NEC Table 310.15(B)16 for the maximum amperage based on the cable gauge size. Cable lengths in excess of 6 feet may require heavier gauge wire to avoid unacceptable voltage drop. When connecting multiple batteries in parallel to make larger battery banks, it is preferable for all parallel cables to be the same length.

For more information refer to the National Electrical Code for correct cable size, which can be located at www.nfpa.org

The battery circuit must be properly fused to handle the expected load and not to exceed the battery specifications.

After installation is complete, turn on the battery power by a short-press of the Power button. The LED indicator should come on to confirm the battery's state.

DO NOT connect multiple batteries in series to get higher voltage as it will damage the internal BMS.

DO NOT attempt to disassemble the battery, as it could lead to permanent battery damage and will void your battery warranty!!!

Battery Charging

Due to shipping laws and regulations, your battery may be received at a partial state-of-charge. The battery should be given a full charge prior to first use.

Most deep-cycle battery chargers will charge the battery, but some could shut off prior to the battery reaching 100% SOC, while others could trip battery's BMS protection. Charge voltage should be set to 14.4V – 14.6V, equalization and temperature compensation must be disabled, and if the charger supports float mode, set it to 13.4-13.6V. If the charger has multiple profile settings, set it to a “bulk charge” mode (constant voltage / constant current) followed by a “float” mode (constant voltage) such as “AGM” profile. If you are not sure your charger is suitable for your battery, contact Lithionics Battery or your dealer to confirm charger compatibility, or to purchase compatible charger. Please note that voltage rise during bulk charge stage is very slow, followed by a fast voltage rise at the end of charge. Once charge is completed, voltage drops down to a resting level. This behavior is normal and should not cause any concerns.

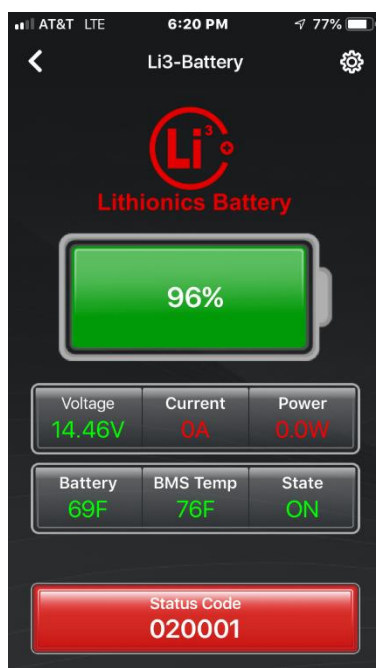
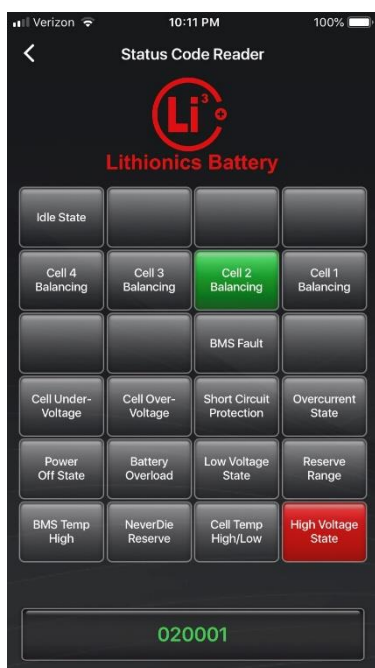

NOTE: Due to partial state-of-charge during storage and shipping, the cells inside the battery might not be perfectly balanced during the first few charge cycles. You may observe some high voltage alerts and cell balancing status codes on the Lithionics Battery Monitor app, which indicate the balancing process is in progress. This is perfectly normal behavior and should not cause any concerns. After a few full charge cycles the cells will balance out and these alerts will disappear. There is no adverse effect on battery operation, you may continue to use the battery normally during these initial charge cycles.

Screen shots on the left show examples of status codes related to cell balancing.

LED Indicator

The NeverDie® Compact Battery has an LED indicator integrated into the Power button on the unit itself. Some models may have provisions for a remote LED and Power button, but their function remains the same. Refer to the table below for an explanation of the LED blink patterns.

Battery State	LED pattern	LED Blink pattern over time			
Discharging	Solid ON	[Solid blue bar]			
Charging	Slow blink	[Blue bar] [White space] [Blue bar] [White space] [Blue bar] [White space] [Blue bar] [White space]			
Powered Off	Solid OFF	[White space]			
Low Battery	Short blink	[Short blue bar] [White space] [Short blue bar] [White space] [Short blue bar] [White space] [Short blue bar] [White space]			
Idle	Short dual blink	[Short blue bar] [White space] [Short blue bar] [White space] [Short blue bar] [White space] [Short blue bar] [White space]			
Fault Alarm	Rapid blink	[Rapid blue bar] [White space] [Rapid blue bar] [White space] [Rapid blue bar] [White space] [Rapid blue bar] [White space]			
		< 1 second >	< 1 second >	< 1 second >	< 1 second >

Battery Management System Definitions

It is important to understand some common terms describing a lithium battery's operation, which are often used in detailed feature descriptions further in this document. It also helps to visualize a charge/discharge graph of a typical lithium battery, to see various voltage points and how they relate to state of charge.

- **VPC – Volts Per Cell.** A Lithium Battery contains several cells connected in series. Battery voltage is a sum of all cell voltages. LiFePO4 chemistry cells are 3.20 VPC nominal (i.e. average voltage during discharge). A typical 12V battery has 4 cells in series, also known as a “4S” configuration. Since the BMS monitors and acts at the individual cell level, it is more common to refer to cell level voltages, abbreviated as VPC. For example, a fully charged and rested cell is at 3.40 VPC, which means a 12V (4S) battery would be resting at 13.6V. Multiply VPC x 4 to calculate the approximate battery voltage.

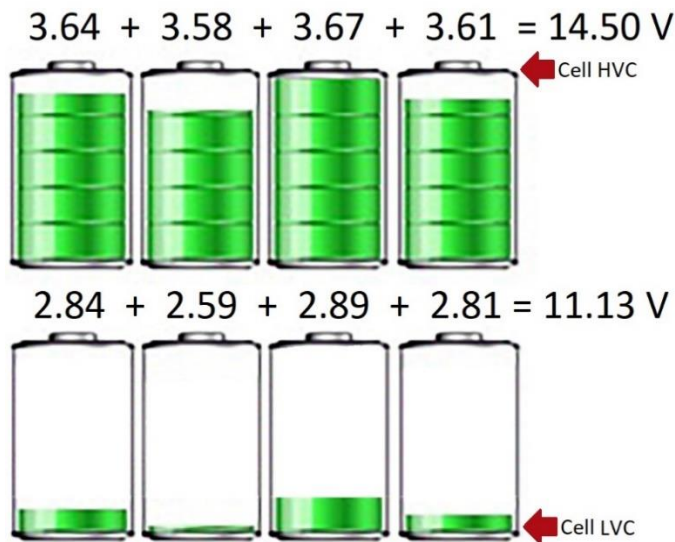

The images on the left illustrate the cell level and pack level voltages of the battery. Due to manufacturing tolerances and environmental factors, individual cell voltages may not always be the same. As a result, the BMS must employ cell level triggers for protection events such as HVC and LVC (defined on the next page). The NeverDie® Compact BMS also works to minimize those voltage differences in a process called “balancing”, which occurs at the end of each full charge cycle.

- **Charge / Discharge Curve.** One of the main advantages of a Lithium battery compared to a Lead-acid battery is its flat charge/discharge curve. This means that the battery voltage stays relatively constant for most of the charge/discharge cycle, with sharp “knees” on both ends where the voltage rises and drops very fast. Constant voltage means that stable power is supplied to loads, making them operate more efficiently and consistently. However, this also renders voltage-based SoC (state-of-charge) measurements ineffective since the voltage is so stable. Voltage based SoC estimates can only be done at the upper and lower “knees” where voltage change is more pronounced.
- **RVC – Reserve Voltage Cutoff.** Set to 3.00 VPC on voltage based BMS triggers. At this level the BMS will shut off the battery power allowing the NeverDie® Reserve Power capacity to be stored in the battery for an emergency, such as engine cranking. The areas shaded red in the picture below represent the Reserve Power. In some applications the RVC feature may be disabled to allow full use of the battery's capacity without interruption.
- **LVC – Low Voltage Cutoff.** Set to 2.80 VPC. At this voltage the battery is almost fully discharged, so the BMS shuts off the battery to prevent damage due to over-discharge. At this point the battery should be recharged immediately.

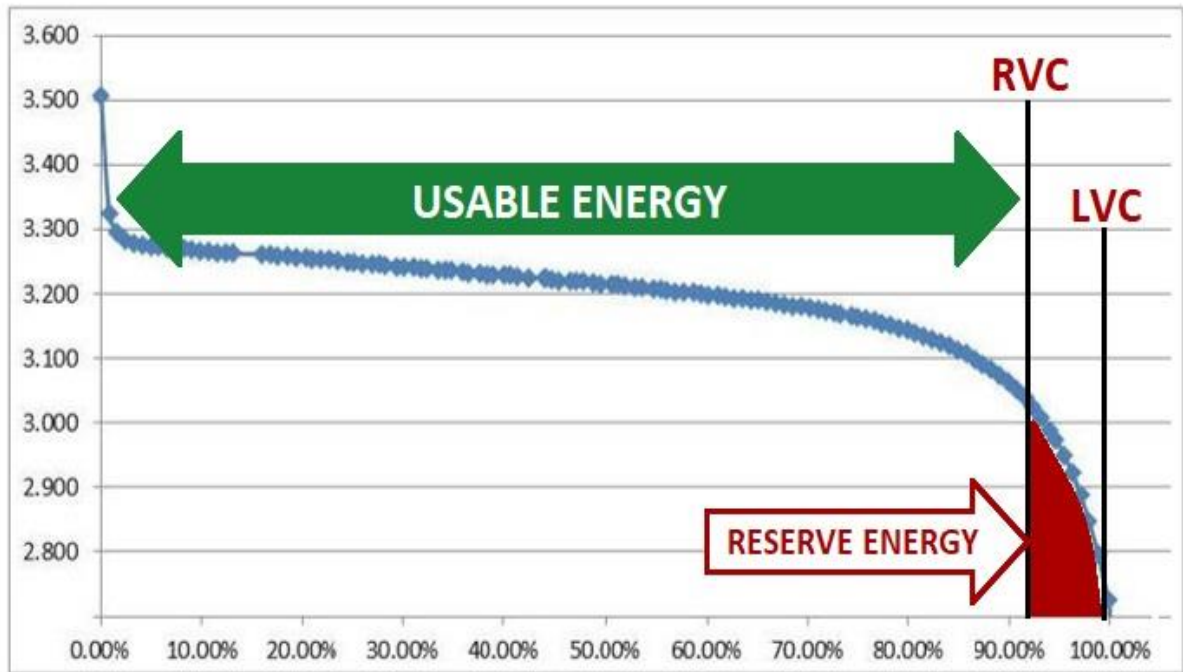

Discharge Curve

- HVC – High Voltage Cutoff.** Set to 3.70 VPC. At this voltage level the cell is not taking any more charge, so voltage rise becomes exponential and if left unchecked would cause permanent damage to the battery. The BMS shuts off the battery when any cell reaches this level which allows the voltage of the cell to reduce. The BMS will automatically re-enable power when all cells voltage reduces below 3.45 VPC.
- Balancing Stage.** As the battery nears the end of charge, the cells enter the upper knee of the charge curve, where voltage rise becomes exponential. Due to the individual manufacturing differences between cells, some cells may reach this stage earlier than others, causing voltage imbalances between the cells. While not harmful in the short term, in the long term such an imbalance will become more and more pronounced with every cycle which eventually reduces the useful capacity of the battery. To counteract this process the BMS performs cell balancing by slightly discharging the higher voltage cells. This process is similar to “equalization” in a Lead Acid battery but requires precise control by the BMS for each individual cell.

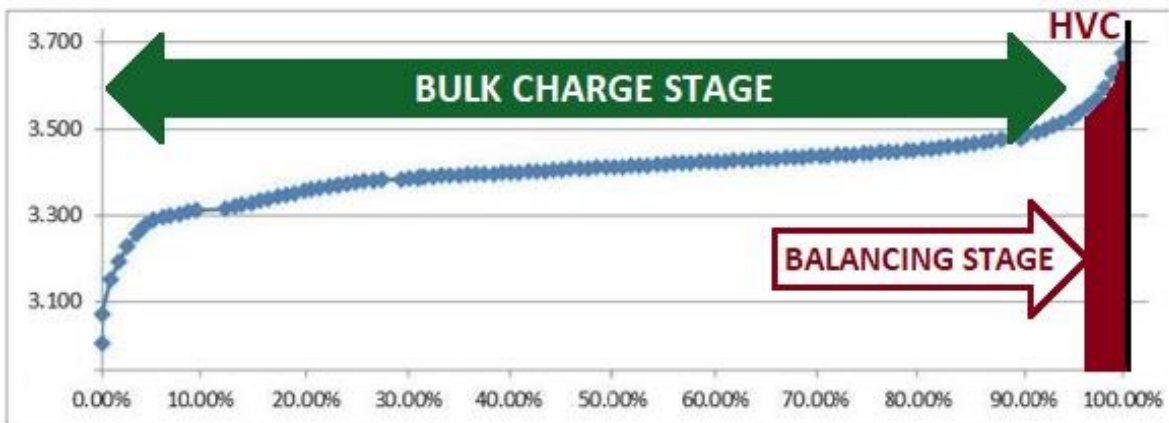

Charge Curve

Battery Operation

The flowchart below depicts a typical BMS operation cycle when the battery is fully depleted or at risk of overcharge by a rogue/faulty charging source. The NeverDie® BMS does not need to intervene in normal charge and discharge cycles, i.e. has an opportunity to charge before being depleted.

For simplicity reasons this flowchart only shows basic protective BMS functions based on voltage triggers. Additional BMS functions based on current, temperature and other advanced functions are not shown in this flowchart. Please refer to the Advanced BMS Functions chapter below for details of those functions.

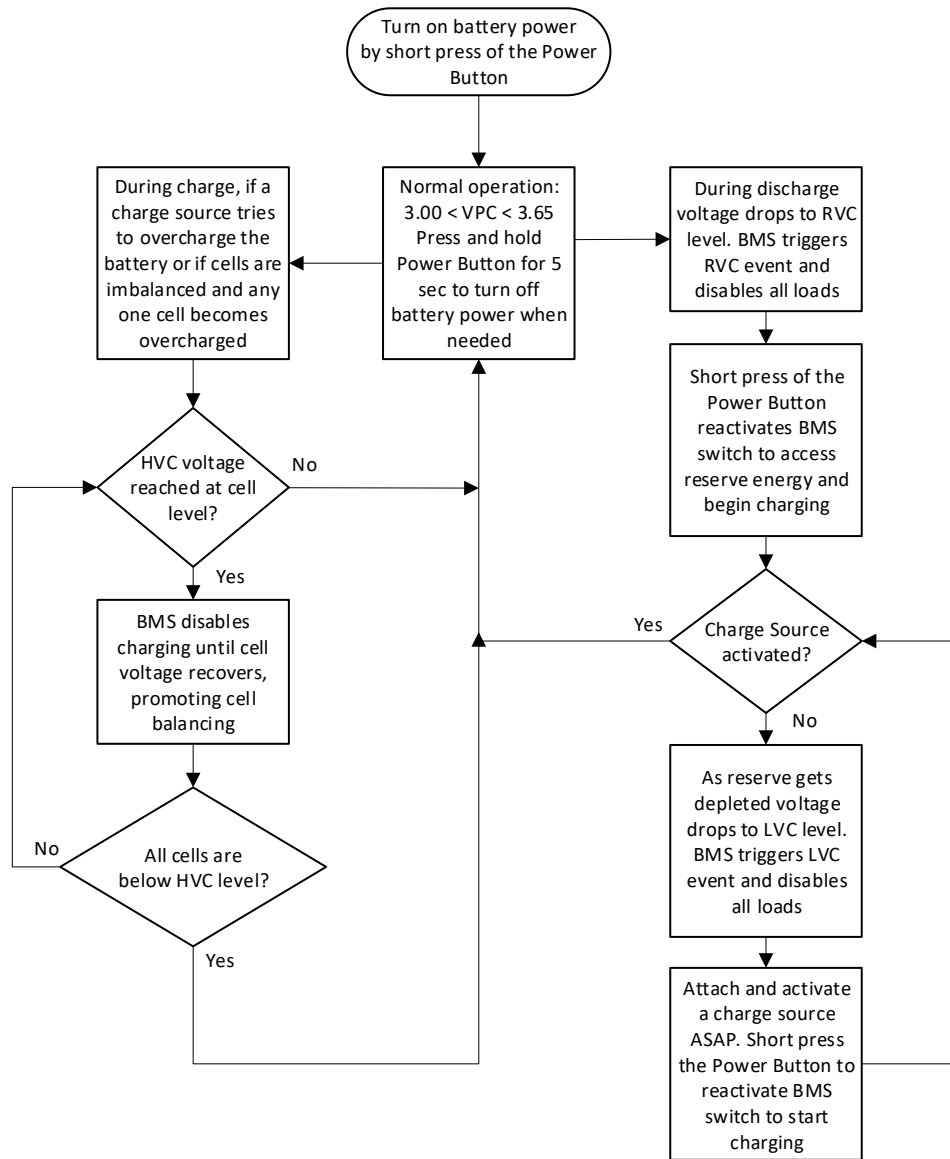

BMS Operation flowchart

Advanced Battery Functions

Below is a detailed description of advanced BMS features and how they affect the state of the battery. Some features depend on setup parameters which are described in detail in the Configuration section of this user guide.

- **Power On/Off** – Briefly press the Power button to turn on the BMS and enable battery power. The battery can be turned off by holding the Power button for 3 seconds.
- **Reserve Voltage Cutoff (RVC)** – NeverDie® function. During discharge the BMS will disable discharge current when any cell reaches the RVC level, which allows the battery to store a small energy reserve. Once the battery is in the RVC state you can access the reserve capacity by a short-press of the Power button.
- **Low Voltage Cutoff (LVC)** – During discharge the BMS will disable discharge current when any cell reaches the LVC level. Charging current is allowed, so that the battery can be charged by activating a charging source. Some charging sources require to “see” the battery voltage before allowing charging, in which case LVC lockout can be temporarily overridden by holding down the Power button. This override will allow the charger to sense the battery voltage, so charging can begin.
- **High Voltage Cutoff (HVC)** – During charging, the BMS will disable charge current if any cell reaches the HVC voltage level. This should not happen during normal operation if charging sources are setup with correct voltage levels. Once the charge current is removed, battery voltage will slowly lower to resting level, typically 3.40 VPC. If your charging source has a “float” mode, it should be set to 3.40 VPC, which is a resting voltage of a fully charged cell.
- **Temperature Based Cutoff** – When the internal battery temperature goes below or above the preset safe limits the BMS will disable charge or discharge current to prevent further use of the battery until the temperature returns to safe operating limits. Different temperature limits are enforced for charging and discharging due to the nature of Lithium chemistry. Discharge safe range is -4F to 131F, charge safe range is 32F to 113F.
- **Over Current Protection** – The BMS will disable discharge or charge current if the current/amperage value exceeds the preset thresholds. To restore normal operation, remove/address the source of the overload, then short-press the Power Button.
- **Short Circuit Protection** – The BMS will immediately disable discharge current if the current value exceeds 1000A. To restore normal operation, remove/address the source of the short circuit, then short-press the Power Button.
NOTE: The lithium battery is capable of significant power output and may maintain the voltage level during a short circuit event, producing a very large current, capable of melting or welding connection points and damaging cables and connectors. Even when the BMS detects the short circuit and tries to open it, the BMS switch itself might weld under such large current. Make sure the battery connection is always properly fused and does not rely on the BMS alone for short circuit protection!

Bluetooth Telemetry

Lithionics Battery has developed the **Lithionics Battery Monitor** app for iOS and Android mobile platforms, which allows real time monitoring of battery data if the BMS is equipped with the **optional** Bluetooth BLE module. The battery must be turned on via the Power button before the Bluetooth connection can be made. When the battery is turned off, the Bluetooth interface is powered off to reduce the quiescent idle power consumption. This app can be downloaded for free on the Apple App Store and the Google Play Store on your iPhone, iPad, Android phone or tablet.

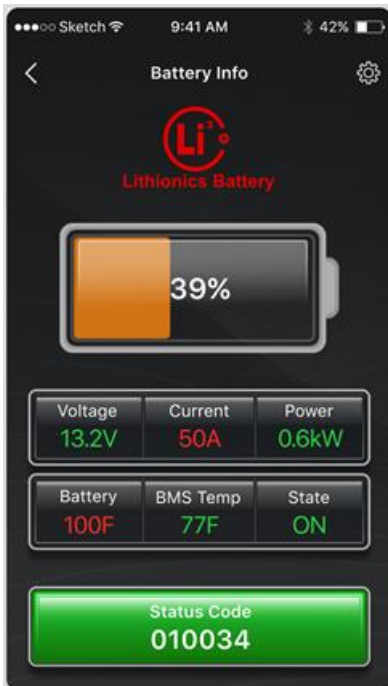

Once the Bluetooth connection is made to the battery, the **Battery Info** section of the app automatically displays. This section provides useful data such as the SoC (State of Charge) percentage, voltage, current, power, internal cell temperature, BMS electronics temperature and the state. Clicking on the Status Code at the bottom automatically opens the Status Code reader section.



The **Status Code Reader** section of the app makes it easy to visualize the status of each bit by typing in the System Status code and observing the color-coded table, see example to the left.

Each active bit description is color coded in green or red, where green indicates informational bits and red indicates faults or critical conditions requiring attention, such as immediate need to charge the battery.

Status Code Bit Values

One of the data values in the BMS Data Output is called Status Code, where each bit represents one of the basic conditions of a battery in real time. It's 6 characters long and coded in Hexadecimal digits '0-F'. Each HEX digit represents 4 bits of binary data, for a total of 24 bits of data.

Description of Status Code bits:

HEX Digit 6				HEX Digit 5				HEX Digit 4				HEX Digit 3				HEX Digit 2				HEX Digit 1			
23	22	21	20	19	18	17	16	15	14	13	12	11	10	9	8	7	6	5	4	3	2	1	0

- Bit 0 – High Voltage State.** Indicates that battery voltage is above HVC, typically 3.70 VPC.
- Bit 1 – Cell Temperature High/Low.** Indicates that cell temperature is outside of allowed operating range.
- Bit 2 – NeverDie® Reserve State.** Indicates that battery is in the NeverDie® Reserve State, allowing access to reserve energy.
- Bit 3 – BMS temperature is high.** Indicates that temperature of BMS's internal MOSFET switch is too high, typically due to high charge or discharge current.
- Bit 4 – Reserve Voltage Range.** Indicates that battery voltage is below RVC, typically 3.00 VPC.
- Bit 5 – Low Voltage State.** Indicates that battery voltage is below LVC, typically 2.80 VPC.
- Bit 6 – Battery Overload.** Indicates that charge or discharge current is too high.
- Bit 7 – Power Off State.** Indicates that battery was turned off by the Power Button.
- Bit 8 – Overcurrent State.** Internal BMS hardware flag for Over Current condition.
- Bit 9 – Short Circuit Protection.** Internal BMS hardware flag for Short Circuit condition.
- Bit 10 – Cell Over-Voltage.** Internal BMS hardware flag for Over Voltage condition.
- Bit 11 – Cell Under-Voltage.** Internal BMS hardware flag for Under Voltage condition.
- Bit 13 – BMS fault.** Internal BMS hardware flag for BMS chip fault.
- Bit 16 – Cell1 Balancing.** State of balancing circuit for Cell 1.
- Bit 17 – Cell2 Balancing.** State of balancing circuit for Cell 2.
- Bit 18 – Cell3 Balancing.** State of balancing circuit for Cell 3.
- Bit 19 – Cell4 Balancing.** State of balancing circuit for Cell 4.
- Bit 23 – Idle State.** Signals
- Bits 12, 14, 15, 20-22.** Not used, reserved for future development.