



STERLING POWER

English Manual

EURO 6+

WARNING: Important
For our regular customers who fit many of these devices. Upgrades have taken place with this new product on the ignition feed line.

Please note the new ignition feed cable location has changed and link wires are no longer required.

Pro Batt Ultra - Battery to Battery Charger

USERS MANUAL.

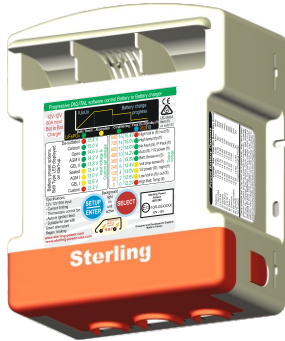

- Code:**
- BB1260 12V-12V 60-80A input
 - BB122470 12V-24V 70-90A input
 - BB123670 12V-36V 70-90A input
 - BB124870 12V-48V 70-90A input
 - BB242435 24V-24V 35-45A input
 - BB241235 24V-12V 35-45A input
 - BB123670 12V-36V 70-85A input
 - BB124870 12V-48V 70-85A input



- Code:**
BB1230
12V-12V 30-40A input



Test Report Sheet

Each product gets uniquely tested and a report is generated. This unique test report is present inside this box. You must keep this test sheet in this box and keep this box safe. This sheet should be present when the charger is being warranted.



For other European languages refer to website:
Europe / RoW: www.sterling-power.com
North America: www.sterling-power.usa.com



battery temp sensor



Optional Remote Instructions inside

These instructions are for the NEWER green stripe BB models

MUST READ

For the majority of users, reading this paragraph should be sufficient for installation. The unit can be installed by simply connecting it between an input and output battery as depicted. The unit, by default, shall start charging when the input voltage exceeds 13.2V and switches off when the voltage drops below 13.0V for more than 240s (adjustable). Going above 13.2V for 5 seconds shall reset this timer. The default charging profile is 14.4V abs. and 13.6V float - for sealed lead acid batteries (x2 for 24V | x3 for 36V | x4 for 48V). This means that the vast amount of installations can be fitted out of the box without any adjustments. In certain circumstances, when installing in a Euro 6 vehicle, you may have to use an ignition feed to the unit. When the ignition is live, unit starts charging (may take up to 60seconds). Please read the manual for additional information. If in doubt, and installing on a New Euro 6+, use ignition feed.

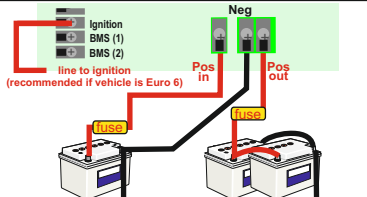

default mode does not require ignition feed

Please read the legal and safety information first before proceeding and we strongly advise hiring a professional to fit.

Copyright © 2018
Sterling Power
April 2018 V65+



RoHS compliant



▶ Contents Page

New features

| | | | |
|--|-------------------|--|-------------------|
| Legal and Safety Information | Page 3 | Force Options - Device options | Page 10 |
| How to use the instructions | | Factory Reset | |
| Copyright and Plagiarism | | Force operation w without output voltage | |
| Maintenance and Repair | | Force Float mode | |
| Safety and Precautions | | Force Unit on / off | |
| Display annotations | Page 4 - 5 | Force Unit to half power mode | |
| Front Label display annotated | | Sleep timer / Off timer adjust. | |
| Under the lid annotation | | Custom Battery Profile Selection | Page 11-12 |
| Recommended cable and fuse sizes | | Customise Boost / Absorption voltage | |
| Quick Installation guide | Page 6 | Customise Conditioning voltage | |
| Basic wiring diagram | | Customise Float voltage | |
| BMS Lithium Battery Information | | Customise Absorption time factor | |
| Guide to Buttons | Page 7 | Customise minimum and maximum absorption times | |
| OEM lock information | | Customise Operational Voltages | |
| Detailed Installation guide | Page 8 | Remote Control Operations | Page 13 |
| Operational modes 1 2 3 | | Comprehensive breakdown of remote functions | |
| Installation diagram | | Fault Finding Troubleshooting | Page 14 |
| Wiring the correct operational mode | | Fundamental fault + troubleshooting | |
| EURO 6 choosing correct mode | | LED displays w / meanings and solutions | |
| First Turning the unit on | Page 9 | Sterling's Warranty Statement | Page 15 |
| Changing the Battery Chemistry Profile | | Customer service and warranty declaration | |
| Battery Chemistry voltage values table | | | |
| Front panel meter readings / meanings | | | |

▶ Product Specifications

| | BB1230 | BB1260 | BB122470 | BB123670 | BB124870 | BB241235 | BB242435 |
|-----------------------------------|---|---------------|----------------------------|-----------------|-----------------|-----------------|-----------------|
| Input Voltage (VDC) | 11 - 20 | 11 - 20 | 11 - 20 | 11 - 20 | 11 - 20 | 22 - 40 | 22 - 40 |
| Input Current (A) | 30-40 | 60-80 | 70-90 | 70-90 | 70-90 | 35-40 | 35-40 |
| Battery types (all models) | AGM (2) GEL (2) SEALED OPEN LiFePO ₄ CALCIUM CUSTOM | | | | | | |
| IP rating | IP21 | IP21 | IP21 | IP21 | IP21 | IP21 | IP21 |
| Ignition Protected | Yes | Yes | Yes | Yes | Yes | Yes | Yes |
| Quiescent Current (mA) | 1 | 1 | 1 | 1 | 1 | 1 | 1 |
| Battery Connector | WJ116VW | WJ116VW | 8mm input WJ116VW output | | WJ116VW | WJ116VW | |
| Weight (Kg) | 1.2 | 1.4 | 1.4 | 1.4 | 1.4 | 1.4 | 1.4 |
| Dimensions (LxWxD) mm | 190 x 160 x 50 | | | 190 x 160 x 70 | | | |

▸ Legal and Safety

Using the Instruction Manual

This manual must be read throughout before installing this electronic device. Do not lose these instructions - keep them safe. The most up to date instructions can be found on the Sterling Power website. Please refer to the latest instruction manual before contacting Sterling. At Sterling, we endeavour to include all of the product information that we can think of into the manual.

Installation of the electronic device must be carried out by a qualified and trained personnel only. The personnel must be familiar with the locally accepted guidelines and safety measures.

Sterling Power's warranty statement

A comprehensive warranty statement is provide at the back of the instruction manual. A comprehensive warranty statement can also be found on sterling-power.com.

Copyright and plagiarism

Copyright © 2015 Sterling Power. All rights reserved. Reproduction, transfer, distribution or storage of part or all of the contents of this document is strictly prohibited. If you wish to use all of this document, or excerpts from it, Sterling Power must be contacted.

Liability

Sterling Power can not accept liability for:

- consequential damage due to use of this device
- possible errors in the manuals and the results thereof

Device modification

Please do not modify the device unless you have been instructed to do so by Sterling Power, directly. Product modification shall be done at Sterling, when needed. Warranty shall be voided if personal attempts are made to modify the device, without Sterling's approval.

Use the battery to battery charger only:

- For DC to DC conversion.
- For DC current limiting.
- With fuses protecting the DC cables.
- In a well ventilated, dry, dust-free and condensation free environment.
- When instruction manual has been read through.

Safety Symbols



- **Example - WARNING.** Never use the device in situations where there is danger of gas / dust EXPLOSION or potentially flammable products.

General maintenance and repair

The device must be switched off during maintenance. It must also be protected against unexpected switching off. Remove battery connections and ensure unit is off. If repair is required, only use original parts.

General safety and installation precautions

- Install device in well ventilated space. Do not expose device to: Rain, snow, spray, moisture, pollution, condensation. Do not cover or obstruct ventilation openings.
- Device connects to common negative. Common negative must be earthed.
- In case of fire use a fire extinguisher.
- Ensure reverse polarity and short circuiting is avoided - to prevent damage to battery.
- Protect DC wires with the appropriate sized fuse.
- Check cabling annually- fix where needed.
- Avoid contact with device with damp hands.
- Ensure the device is adequately and securely mounted to prevent the unit from displacement.
- Use a professional to install device.

Battery safety

Excessive charge or discharge and high voltages can cause serious damage to batteries. Never exceed the recommended limits. If battery acid contacts skin or clothing, wash immediately with soap and water. If acid enters the eye(s), immediately flood the eye(s) with running cold water for 20 minutes and seek medical attention.

Give extra care to not drop metal tools or jewellery on to the battery terminals as short circuiting can take place. Refrain from charging battery up to 4 hours prior of installation to avoid the formation of explosive gases.

Never smoke / generate a spark around batteries.

Front Panel

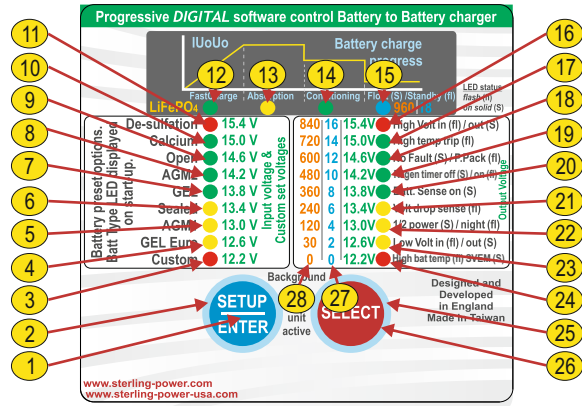

Models:

BB1260 / BB122470 / BB123670 / BB124870 /
BB242435 / BB241235 / BB123670 / BB124870

Front label display

1 & 26) ENTER / SETUP and SELECT buttons, used to adjust settings.

2 & 25) Background light for button, used also to show unit is operational.

3)-11) The left column of LEDs have 3 different functions. Firstly, on unit start up the battery type is displayed. Secondly, after startup it becomes an input voltmeter. Thirdly, during custom setting the voltage scale is used to set the voltage - refer to later.

12) This LED has 3 meanings. Firstly, when on battery type selection mode this is the LiFePO₄ lithium battery indicator. Secondly, on default mode (most times) this shows the charger is on fast charge mode. Thirdly, if flashing, then the unit is in standby and was in fast charge prior to entering standby.

13-15) These LEDs show the battery charge progression through its cycle.

15) Flash when in standby.

16-24) Has 3 functions: Firstly, during operation they show the output voltage. Secondly, if an alarm is present the alarm shows up. Thirdly, this row is used in the custom setup procedure to set timing functions, voltages and time factors. Its general function is as an output voltmeter, in the event 2 LEDs are on the voltages is between the 2 settings, if the top or bottom red LED is on then the voltage is outside the parameters of the voltmeter.

16) High voltage, if on solid it is high output voltage, if flashing it is high input voltage.

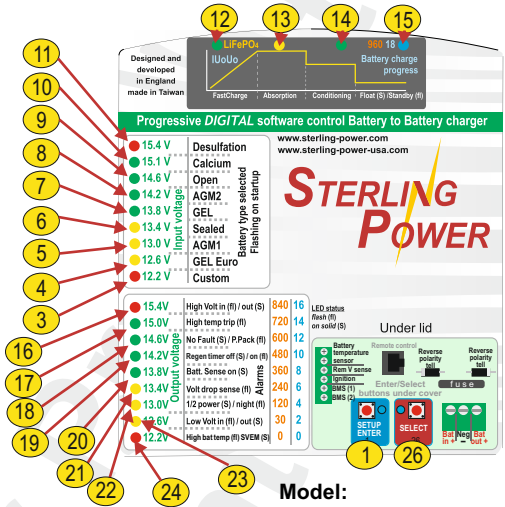

Model:
BB1230

17) High temp trip, if flashing then high unit temperature trip.

18) No faults (solid on). Power Pack mode / live voltage output (flashing).

19) No regen. mode or regen. timer at 0 = solid LED. Regen on / timer on = flashing LED.

20) Remote Battery sense cable connected (solid).

21) Battery sense voltage drop in cable outside the prescribed 1.5V drop maximum, thicker cable required - LED flashing.

22) Device's power ability reduced due to high ambient temperature or voltage drop in output cable to big. Alarm will be in conjunction with other information alarm. If flashing unit is in night mode with reduced power and low fan speed.

23) Low voltage alarm, low voltage on input = flashing LED. Input alternator not supplying enough power or failed. Low voltage output = solid LED. Something consuming a lot of power or unit not working. No voltage output then LED on solid.

24) If flashing then battery temperature too high. Solid LED is in **SVEM mode - Stationary Vehicle Engage Mode**.

27) Numbers relating to battery custom setup (if used) this is the charge factor number.

28) Numbers relating to custom setup mode these numbers relate to timing, i.e. maximum and minimum time settings.

▶ Quick Installation

Unit will work on default setting if temperature sensor not fitted

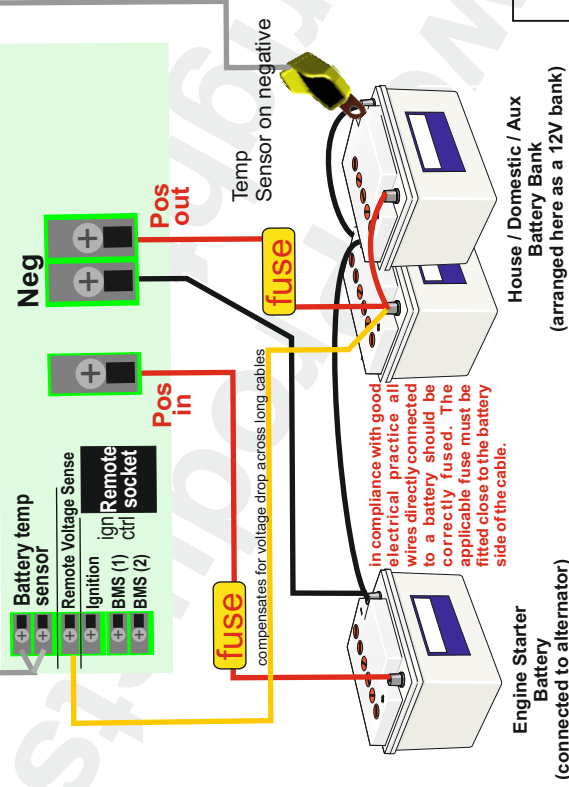

Temperature sensor



Not obligatory to connect. If you wish to install, connect the temp sensor to the negative of the domestic / aux. batteries.

When temp sensor senses the temperature lower than 20Deg C the voltage shall go up on the charger's output and when the temperature is higher than 20Deg C the voltage.

Sensor shall trip the charger if the temperature of battery >55DegC.

Important
NEGATIVES
 should all be common. **DON'T USE CHASSIS**
 We recommend joining the BB's neg. to the starter battery negative. **For improved efficiency.**

Negatives: The reason to not use CHASSIS ground is that the conductivity is poor. This shall result in worsened performance. Output voltage shall climb at a slower rate. Charging rate shall be slower. Please use direct cable for best performance.

Engine Starter Battery (connected to alternator)

House / Domestic / Aux Battery Bank (arranged here as a 12V bank)

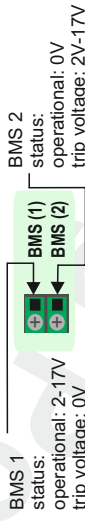

▶ Lithium Battery installation | BMS shutdown

Lithium batteries present a few extra challenges due to the lithium safety BMS protocol in conflict with our safety protocol. I.e. if your lithium battery becomes sufficiently discharged then the battery will totally isolate your lithium battery effectively removing it from the charging circuit and, as such, presenting our Pro Batt Ultra with 0V. This means our default safety system sees 0V and will not start up due to our reverse polarity protection system. To overcome this problem after installation simply remove our reverse polarity protection by pressing and holding the SETUP button for 15-30 seconds, let go, then press the SELECT button firmly once – LED24 shall flash, then press both SETUP and SELECT. If successful, the output of the BB shall be a live 14V or so without any battery connected to the output terminal.

Use BMS 1 - if your BMS trips and provides a 0V (ground signal), then use BMS 1. This shall result in the BBC turning off when this off. Once the BMS removes this trip status, i.e. the 0V signal goes back to a +ve signal, the BBC shall start charging again.

OR

Use BMS 2 - if your BMS trips to a +ve voltage (2V-17V), then use BMS 2. This shall result in the BBC turning off when this voltage is received. Once the BMS removes this trip status, i.e. the +ve signal goes back to 0V signal, the BBC shall start charging again.

Remote trip - the BMS connector can also be used as a basic remote trip. Simply apply the correct trip signal voltage to the relevant BMS connector for the desired effect.

| Press Length (s) | Action |
|------------------|--|
| 2-5 | Forces unit into float mode. Press again to take out of float mode. |
| 5-10 | Turns unit on / off toggle. |
| 10-20 | Battery type select - use SETUP / SELECT to toggle between types. Both to confirm. |
| 20-30 | Change operational on/off voltages - use both buttons to scroll between voltages. |
| 30+ | Reset unit to default. Then press and hold both buttons for 2 seconds to confirm. 2 x 3 sets of green LEDs shall flash to confirm. |

| Press Length (s) | Action |
|------------------|---|
| 0-1 | Change to status fault display / back to Voltage display mode. |
| 5-10 | Toggles between 1/2 and 1/1 (full) power. |
| 10-15 | Set Auto Regen. time - use either buttons to toggle between the preferred time. |
| 15-30 | Live output voltage (power supply mode) - press SELECT to change to LED 24. |
| 30+ | OEM lock - disables further adjustment of unit's functions. |

OEM lock - press Setup button for 30+ seconds - 4 x red LEDs should light to confirm. repeat procedure to remove the lock.

This mode prevents operators tampering with the unit's settings when in the field. The OEM / fitter can set the unit up as they desire first, the settings shall be stored, then they can apply this lock.

| Press Length (s) | Action |
|------------------|--|
| 2-5 | Night mode = 1/2 power for 8 hours, then back to full power. |
| 5-10 | Enter standby mode. To take out of standby, repeat. |
| 10-15 | Display software version (displayed in binary on display). |
| 15+ | SVEM - Stationary Vehicle Engage Mode |
| 40+ | Turns off alarm buzzer indefinitely. Repeat procedure to reapply alarm buzzer. |

SVEM*
Stationary Vehicle Engage Mode
 Pro Batt Ultra starts charging when input is >13.1V.
 Turns off when input is <13.0V.

Basic Operation / Installation

8

Fit in a cool dry well ventilated space. Should be installed by a competent person, conforming with the laws of the country. Connect positive cables (in red) to the terminal block, as shown below. Similarly, ensure fuses are installed and negatives are common.

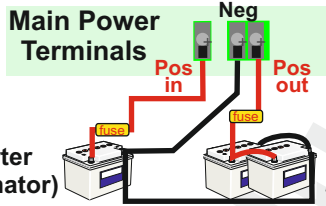

Important
NEGATIVES
should all be common.
DON'T USE CHASSIS POOR CONDUCTORS
RESULT IN WORSE CHARGE RATE

Engine Starter Battery (alternator)

House / Domestic / Aux / Bow thruster

Ensure the charger is wired up as depicted above (larger diagram on previous page). The Pro Batt Ultra shall light up provided it has battery voltage across the **Pos in** and **neg** terminal. If **Pos out** is also connected the unit shall start charging for 120 seconds (1/2 of the regen. braking timer). During the first start up you can change the battery chemistry profile.

In default mode (1) the Batt Ultra shall simply turn off and goes to sleep after 240 seconds (can be changed) if the input voltage has not risen above 13.2V. **WARNING**, If you have it set to Ignition Mode, and the ignition is live, then the charger shall continue charging until the input battery drops to **10.0V** (default) x2 for 24V. **VERY LOW**.

In default mode the input voltage needs to rise to above 13.2V-19.0V (x2 for 24V) in order for the Batt Ultra to start charging. This can be achieved by starting your engine. Above 13.2V, for 5 seconds, the regenerative braking timer activates (120 sec (first time after start/wakeup) then 240 seconds default).

There may be a delay of up to 60 seconds before the BB ultra starts.

This is required to complement the regenerative braking aspect of modern Euro 5/6+ engines - where the alternator's voltage can drop below 13V for a short period of time. When the alternator's voltage rises above 13.2V the 240 second timer ends (+ reactivates the timer) and the charger remains charging.

2 Operational Modes (Both work with Euro 6 vehicles - please read for subtle difference)

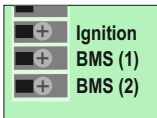

1 mode 1

Leave 'ignition' connector vacant

Automatic activation (default setting). The most common mode, used in 50% of all installations including vehicles with some EURO 6 / Regen. braking systems (depending on application). This means that the unit is voltage sensitive (no ignition feed required unless Euro 6 vehicles are being used in a stationary application - at idle at the side of the road). When the input voltage exceeds 13.2V-19.0V (x2 for 24V) then the unit will simply start charging. If the voltage drops below 13.0V the unit shall turn off. With a caveat, read on.

However, if the input voltage has exceeded 13.2V (2x for 24V) for 5 seconds the regen. braking timer is prepped and shall become active if the input voltage drops down to 12.0V-13.3V. This timer is 240s (default - can be changed) and allows the charger to continue charging at these lower input voltages. If the voltage drops below 11.9V the charger goes to sleep irrespective of the timer. If the input voltage remains between 11.9V-13.0V for over 240s the charger also goes to sleep. To wake the charger, the input voltage needs to rise above 13.2V - this shall also reset the regen. braking timer.

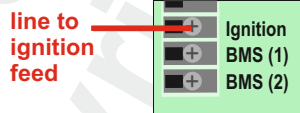

2 mode 2

Ignition Feed Mode.

Apply an ignition feed cable to the 'Ignition' terminal on the connect block.

As soon as there is a signal (> 4V) on this connector, the unit will wake up (can take up to 60 seconds) and will start to charge the output battery. The only limit is the input voltage. It will charge down to 10V on the input side. When ignition is turned off (0-4V) the BB shall continue charging at 'mode 1' charging parameters. **WARNING: If ignition on the vehicle is left on and the engine is off, you shall deplete your starter battery down to 10V. Also, if your alternator is less than 60A or can not produce 60A at idle revs you may discharge your starter battery.**

WARNING: the BB shall start up by **mode 1** voltage parameters if there is a line feeding the ignition at <4V. We have done this to allow users to put solar or an AC to DC charger onto the starter to enable the BB to charge the leisure / aux battery without running an additional ignition supply.

Euro 6 vehicle (which to choose).

If your usage of the vehicle includes situation applications where the vehicle engine is being run for long periods at idle and stationary. I.e. you are simply switching the engine on to charge the auxiliary battery system **but not driving**, then you must use the ignition feed mode, **Mode 2**.

We appreciate ign. feeds are a hassle (hence it is optional). Fitting one gives the driver/user more autonomy. **Generally speaking, if in doubt, fit one!**

First Time Use (when wiring up)

9

On first start up all LEDs will light up. A beep should sound. The fan shall then start running for around 5 seconds. If, after this, 2 red LEDs flash for 8 seconds you may have a calibration issue and the unit should be returned to Sterling. If 2 solid red LEDs are on at the top or bottom then you either have high or low input voltage (respectively) - check your voltages.

Changing charging profile during startup

After the initial start up an LED on the left panel shall light up for 5 seconds, this shall indicate the battery type selected - **default is sealed lead acid**. This is your window of opportunity to change the charging profile. If you have missed the opportunity, you can wait for the unit to go in to normal operation and follow the instructions on the right of the page or restart the device.

Hold down both buttons on the front panel (SELECT and SETUP/ENTER) for more than 10 seconds (less than 20 seconds!). All LEDs on the left column shall now flash. By using these two buttons toggle through the various profiles (see below). The right button is up the column and the left button takes you down the column. The LED shall light up demonstrating which profile you have selected. When the LED has illuminated at your desired profile simply hold both buttons for a couple of seconds or simply just leave the charger alone for 30 seconds and it will change. The chosen profile LED shall then flash. The unit shall then restart and go through the starting cycle again.

| | Bulk / Abs. | Cond. | Float | Min | Abs. | Max |
|------------------------|-------------------------|-------|-------|------|------|------|
| Options | Volts | Volts | Volts | Mins | Mins | Mins |
| 1) Gel I | 14.00 | 13.85 | 13.70 | 60 | 600 | |
| 2) AGM I | 14.10 | 13.75 | 13.40 | 60 | 480 | |
| 3) Sealed | 14.40 | 14.15 | 13.60 | 120 | 480 | |
| 4) Gel II | 14.40 | 14.00 | 13.80 | 720 | 1440 | |
| 5) AGM II | 14.60 | 14.10 | 13.70 | 60 | 480 | |
| 6) Open | 14.80 | 14.00 | 13.30 | 60 | 480 | |
| 7) Calcium | 15.10 | 14.30 | 13.60 | 60 | 360 | |
| 8) De-sulphation | 15.50 | | | 240 | 240 | |
| 9) LiFePO ₄ | 14.40 | 13.80 | 13.80 | 30 | 30 | |
| 10) Custom | Custom Charging Profile | | | | | |

If battery temperature sensor is connected then all voltages are based on 20 Deg C. If sensor senses less than 20DegC = increased voltage. Higher than 20DegC = decrease voltage. The further from 20DegC in either direction leads to proportional increase or decrease in the voltage. (x2 for 24V) (x3 for 36V) (x4 for 48V)

***Lithium profile has reverse polarity protection disabled. **All voltages shall be 0.1V higher for the first 3 minutes of the chargers operation.**

Remember it is the voltages which are more important than our battery types. After installation test the voltage from the unit is the desired voltage. **Ensure you remove at least 1 wire from the battery temperature sensor as the product voltage may be higher (if in cold climate) or lower (if in warm climate) than the preconceived voltage. The voltage requirements of the battery company will override our recommendations as it is them who are supporting the battery warranty.**

Changing charging profile during operation.

While the unit is running, simply hold down the SETUP and SELECT buttons for 10-20 seconds and let go. The LEDs on the left column shall light up. The procedure hereafter is the same as above.

After unit has gone through its startup sequence the LEDs displayed should be the input voltage on the left column and the output voltage on the right column. Also, the top left LED (number 12) should be on solid which is the fast charge (bulk) LED.

Note - if you can only see LEDs on the right column the chances are you are in an error mode. This could be down to: Very low output voltages (<5V), no output connection, reverse polarity or the device is not detecting a valid operational mode as the connector wire is either not connected or the connection configuration is wrong. Please refer to previous page.

Left and right meter readings.

During normal operation

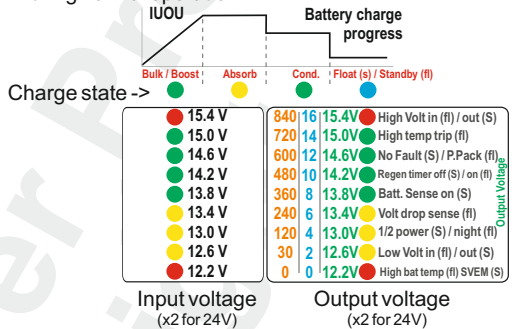

Out of range voltage values

If voltage exceeds the meter's range the upper right LED shall flash. If the voltage falls short of the meter's range the lower LED shall flash. If two neighbouring LEDs, on the voltmeter, are on simultaneously then the real voltage is between these two parameters. Example, if LEDs at 14.6V and 14.2V were on then the approximate voltage shall be ~14.4V.

Low or high output voltages

If the output voltage is below 1V (2V at 24V) or reverse polarity then the low output voltage LED will flash (number 23). Similarly, if the output voltage is above 15.5V (31.0V at 24V) the high voltage LED shall flash (number 16). To resurrect these problems, bring the voltage above 1V on the output and below 15.5V, correct the polarity and then restart the device.

Return to factory default: This shall irreversibly erase all previously entered settings. Press and hold both buttons for 30 seconds+ and let go. The LED columns shall alternatively flash. To confirm factory default press BOTH buttons again for 2 seconds. Once confirmed, 3 green LEDs on both columns shall flash. Then, LEDs on the front panel shall light up in a clockwise pattern. The unit should then reboot with the default settings. To reject factory default settings, simply let the LED columns continue alternatively flashing.

To view charger's status:

Simply hold the SELECT button for 1 second and the right LED should flash indicating the status of the charger. This shall flash for 8 seconds. To return quickly, press the SETUP/ENTER button once.



Force unit to operate without output battery connected (i.e. as a power pack / live output).

This mode shall allow the unit to operate without needing a voltage on the output terminal. Hold down SETUP/ENTER button for 15+ seconds and let go. The boost, absorption and float LEDs shall flash. A green LED (18) on the right panel should appear and this indicates that voltage check is on (default mode) to change it to off (power pack) press the SELECT button and a red LED (24) below should turn on. With the red LED on the unit shall now operate without the need for an output voltage. Press both buttons together to save this setting or wait 30 seconds for the unit to reboot.

On reboot, the HIGH BATT TEMP LED(24) comes on for to confirm power pack mode.

Force to Float :

Before accessing float mode please be sure you know what float mode is and what voltage float mode is for your profile. Simply hold both buttons down for 2 seconds and let go. This will lock the charger into float (BLUE LED - top right - number 15 shall come on). The charger shall now remain in float and resume bulk/absorption on restarting. To force the unit out of float repeat the procedure.

Force unit off / on :

This shall deactivate the unit, output goes to 0.0V. Hold *both setup and select buttons* for 5 - 9 seconds. LEDs shall turn off, the Bulk LED (blue) shall flash once every 5 seconds. The unit will remain off, even with normal engine cycling on and off (although if the unit's negative is disconnected from the input battery then it will resume normal operation on re-connection). To turn the unit back on, hold the 2 buttons for 5-9 seconds. *When OFF, the user can not access charger's normal functions.*

Force unit to 1/2 power (stays on until unit is turned off):

This will reduce the units power by about 50%. Hold *setup button only* for 5-9 seconds. To confirm the power reduction LED shall flash 5 times. This function will help reduce noise in the long term. To return to full power, press the setup button again for 5-9 seconds.

Force unit to 1/2 power / low speed fan for 8 hours only (night mode):

This will reduce the unit's power by around 50% for about 8 hours. **Hold select button only for 2-4 seconds**, power reduction shall be confirmed when the 1/2 power and night LED flashes 4 times. This function will help reduce fan noise in the short term, in the evenings, for example. The unit will revert back to full power after 8 hours automatically. Please note that night mode has to be set every single time you wish to use it. It can **NOT** be set to come on at a certain time daily.

Display software version

By pressing **SELECT** for 10-15 seconds certain LEDs on this column shall briefly illuminate to denote the software version in binary. From the top -> down 'on' LEDs = 1 and 'off' LEDs = 0.

For example, if LEDs 8,7,5,3 are on then the binary is 000110101 which, in decimals = 53. Use a calculator.

| | | |
|---------|----|---|
| Desulph | 11 | 0 |
| Calcium | 10 | 0 |
| Open | 9 | 0 |
| AGM II | 8 | 1 |
| GEL II | 7 | 1 |
| Sealed | 6 | 0 |
| AGM I | 5 | 1 |
| GEL I | 4 | 0 |
| Custom | 3 | 1 |

binary # ↗

Regen timer adjustment: default 240 seconds (Regen low voltage timer time).

The default auto Regen time is 240 sec. = 4 min. The timer is prepped at 13.2V-19.0V on the input. If the input voltage then falls below 13.0V (x2 for 24V) the auto regen timer starts to count. If the voltage does not rise above 13.2V the timer will not reset and the unit will switch off, however, as soon as the voltage rises above 13.2V the auto regen timer will automatically reset to the set value (default = 240sec). To deactivate the auto regen mode set the auto regen time to 0 seconds.

By pressing the **Setup / Enter** only button for more than 10 seconds you will enter the Auto Regen Time Setup. During the whole Auto Regen Setup the "Absorption" LED will flash.

1. Absorption LED flashing and actual saved auto Regen time will be displayed on the right bar. Use the 0 to 840 scale. If the unit is out of the factory the 240 (default) should be displayed.
2. Press right button to increase or left button to decrease value.
3. To deactivate the auto regen function set timer value to 0. When happy with your choice either wait 30 seconds or press both buttons at the same time for 2 seconds.
4. Absorption LED, AGM II and Auto Mode LEDs will flash 10 times to confirm value saving.
5. Unit will restart with new Auto Regen time as default and will remain there until changed again.

Important: If you have changed the cutoff voltage remember that the auto regen counter reset functions must see **0.2V on top of the new cutoff voltage**. I.e. You set the new cut off voltage at 14.0V. To reset the Auto Regen timer the voltage must rise above 14.2V.

SVEM - Stationary Vehicle Engage Mode.

If your usage pattern is mostly stationary, e.g. You are at the side of the road and you start the vehicle just to run an inverter - the problem is that the vehicle's alternator may only be at 13.1V (and not give a high voltage boost) and stay there, in this case the Pro Batt Ultra would not engage as it needs greater than 13.2V to start. The ideal solution is to have fitted the ignition feed mode (as per explained in these instructions). However, if the auto mode was used and the ignition feed had not been installed then you could use the **Stationary vehicle engagement mode**.

This mode allows the product to engage at a much lower voltage (13.1V) and disengage below (13.0V). To select this mode: Press **SELECT** button for 15+ seconds and let go. No Fault LEDs should be on solid and the Regen timer LED should be solid. To remove this setting then do the same again.

Warning: the Stationary Vehicle Engage Mode setting is operating the unit at voltages which may cause problems in the winter to the starting of the vehicle.

Turn off annoying buzzer

If the buzzer alarm is coming on and it annoys you, you can turn it off!. Please press the **SELECT** button down for 40+ seconds. This shall disable the buzzer altogether, indefinitely. You can reapply the buzzer function by repeating this procedure.

► Custom Settings

CUSTOM BATTERY TYPE SETTING (for expert use only - not required for general operation)

Before proceeding with this, please read and understand all instructions as it is quite complex and could take more than one attempt. There are timed intervals of 30 seconds per setting so it is very important to know exactly what you require before starting. If any errors are made simply wait a few minutes and you can start the cycle again. The settings offered for adjustment in sequence:

- A) Boost / absorption voltage (high voltage charge).**
- B) Conditioning voltage (medium charge rate normally between boost and float voltage).**
- C) Float voltage (no longer charging, this will provide voltage at a reduced level to maintain the batteries and provide power for any loads applied).**
- D) Absorption time factor adjust.** The length of time spent in absorption can be adjusted by a factor 0-18. This may be beneficial for different battery chemistries. Gel, for example, tends to absorb current at a low rate, thus, increasing the length of time spent in absorption may be beneficial (set nearer 18). AGM, the reverse (set nearer 0). If in any doubt, ask your battery retailer or simply use one of our preset values. To calculate the absorption time from the time factor simply multiply the factor number (0-18) by the length of time it takes for the charging voltage to hit the absorption voltage (typically 14.4V). If it takes 40 minutes to reach absorption and you set your ATF to 4 then $4 \times 40 \text{ mins} = 160 \text{ minutes}$. The maximum time the unit can stay in absorption is 24 hours 1440 minutes.
- E) Minimum and maximum absorption times.** Here you can set the maximum and minimum time the unit stays in absorption. For example, you may have AGM that may need a maximum of one hour, or GEL which could require a minimum of 720 minutes (12 hours).

We recommend that you write down your required voltages and times in the space below. This is so you know what to programme during setup.

Desired custom values - make a note.

Boost / bulk / absorption (V) _____
 Conditioning (V) _____
 Float (V) _____
 Absorption Time Factor (0-18) _____
 Absorption Minimum (0-960 minutes) _____
 Absorption Maximum (0-960 minutes) _____

Operation

Press and hold both buttons for 10-20 seconds.
All Left LEDs shall flash

Press the setup/select button to move LED down to custom. Hold both buttons for 2 seconds to confirm.

Opportunity to adjust Fast Charge / Bulk / Absorption voltage.

Red Custom LED will flash for 3 seconds to confirm. **Red Custom LED** will come on constant, **Green Fast Charge LED** will flash (section 1 on graph). Adjust Fast Charge voltage by using the Select and Setup buttons to go up and down the right LED column to select the correct Fast Charge voltage. Once content, wait 30 seconds, or press both buttons to confirm. The unit shall then proceed to Conditioning charge voltage (next below).

Opportunity to adjust Conditioning charge voltage

Red Custom LED will come on constant and **Green Conditioning LED** will flash (section 3 on graph). Likewise, adjust the conditioning voltage by using the Select and Setup buttons to go up and down the right LED column to select the correct Conditioning voltage. Once content, wait 30 seconds, or press both buttons to confirm. The unit shall then proceed to float voltage set (next below).

Opportunity to adjust float charge voltage

Red Custom LED will come on constant and **Blue Float LED** will flash (section 3 on graph). Likewise, adjust the float voltage by using the Select and Setup buttons to go up and down the right LED column to select the correct Float voltage. Once content, wait 30 seconds, or press both buttons to confirm. The unit shall then proceed to float voltage set (next below).

Opportunity to adjust absorption time factor

Red High Temp LED will come on constant. **Green Fast Charge LED** will flash and **Blue Float LED** will flash (section 1 and 4 on graph). This time, adjust the time by using the Select and Setup buttons to go up and down the right LED column (refer to the blue scale 0-18) to select the correct time. Once content, wait 30 seconds, or press both buttons to confirm. The unit shall then proceed to minimum absorption time factor (next below).

Why use Absorption Time Factor (ATF)?

ATF is simply a number (0-18) that can be used to multiply by the length of time the charger takes to reach the bulk/boost voltage from start. For example, if the bulk voltage is reached in 10 minutes with the ATF at 4, then $10 \text{ mins} \times (\text{ATF } 4) = 40 \text{ mins}$ of absorption.

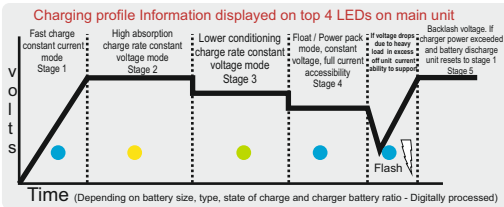

Opportunity to adjust minimum absorption time factor

Red High Temp LED will come on constant. Yellow Absorption LED will flash and blue Float will flash (section 2 and 4 on graph). This time, adjust the time by using the Select and Setup buttons to go up and down the right LED column (refer to the brown scale 0-960) to select the correct time. Once content, wait 30 seconds, or press both buttons to confirm. The unit shall then proceed to maximum absorption time factor (next below).

Adjustment of operational voltages.

The 4 main control voltages below are inextricably linked. The voltages can only be adjusted as a block (not individually). For example, if you wish to reduce the Cutoff voltage by 0.2V then all other voltages in the block shall reduce by 0.2V.

Input voltage

| | | |
|----------------------------|-------|--|
| Charging voltage | 13.2V | All 4 voltages are always linked. This block can be adjusted by changing the Cutoff voltage value up and down. This subsequently changes the other three voltages by the same value. |
| Cutoff voltage | 13.0V | |
| Lower voltage trip | 12.0V | |
| Volt. trip w/ ign (Mode 3) | 10.0V | |

↕ regen braking timer

Charging voltage (default 13.2V) (always 0.2V above Cutoff voltage): At this voltage the charger starts charging. After 5 seconds above 13.2V the regen braking timer is set. If the input voltage drops to 11.9V - 13.0V this timer begins. Timer reset when input voltage is 13.2V+.

Cutoff voltage (default 13.0V): This voltage is only relevant after the charging voltage has been met and the charger is charging. When the input voltage drops below this cutoff voltage the charger stops charging and shall eventually go to sleep. If the input voltage remains between 13.0V-13.2V the charger shall continue charging. The Cutoff voltage is the parameter that the user changes. As noted, by adjusting the Cutoff voltage you change the other three voltages mentioned by the same amount.

Lower voltage trip (default 11.9V) (always 1.1V below Cutoff voltage): When the input voltage drops below the Lower voltage trip the charger turns off. The 11.9V threshold is only relevant if the regen braking timer is activated. If not, then the low voltage trip is 13.0V. If in mode 3, the low voltage trip is 10.0V.

Low voltage trip (default 10.0V) (Mode 3) (always 3.0V below Cutoff voltage): Only when in operation mode 3 does the Pro Batt Ultra work down as low at this voltage.

Opportunity to adjust maximum absorption time factor

Red High Temp LED will come on constant. Green Conditioning LED will flash and blue Float will flash (section 3 and 4 on graph). This time, adjust the time by using the Select and Setup buttons to go up and down the right LED column (refer to the brown scale 0-960) to select the correct time. Once content, wait 30 seconds, or press both buttons to confirm.

A green LED from the middle of each row will flash for around 8 seconds to confirm the setup is completed. The unit will then restart.

During this particular setup procedure we have made the voltage setup LED bar more sensitive so that the adjustment can be made in 0.1V increments. For example, for 13.1V the 13V LED is on and the 13.4V LED is flashing. The same idea for 12.9V. The 13V LED is on and the 12.6V LED is flashing. Remember that you are adjusting the Cutoff voltage whilst simultaneously adjusting the Charging voltage, Lower voltage trip and the Low voltage trip.

| | |
|-------|-----------------------------------|
| 13.4V | 13.4V LED ON |
| 13.3V | 13.4V LED ON + 13.0V LED FLASHING |
| 13.2V | 13.4V LED ON + 13.0V LED ON |
| 13.1V | 13.4V LED FLASHING + 13.0V LED ON |
| 13.0V | 13.0V LED ON |
| 12.1V | 12.2V LED FLASHING |
| 12.0V | 12.2V LED FAST FLASHING |

To enter the menu press (SETUP/ENTER) & SELECT for more than 20 seconds.

BOOST, ABSORPTION, CONDITIONING and FLOAT LEDs will flash to indicate Cutoff voltage Setting Menu. At the same time the actual Cutoff voltage will be displayed in the left LED voltage bar according to the description above. To decrease voltage press SETUP/ENTER and to increase voltage press SELECT button.

The Cutoff voltage range you can choose is between 12.0V-14.6V.

Charging voltage is always 0.2V higher.
Lower voltage trip is always 1.1V lower.
Low voltage trip (Mode 3) is always 3.0V lower.

If you do not touch any buttons for 30 seconds the default voltage of 13.0V shall be restored and saved.

To confirm your custom voltage you must press both buttons (SETUP/ENTER) and (SELECT) simultaneously for 2 seconds.

The chosen voltage will be saved and the unit will restart. If you feel unsure do not touch any buttons. The default value will be restored automatically.

Remote Control

- 1) Volts select button.
- 2) Voltage displayed is voltage into product.
- 3) LCD screen with backlight.
- 4) Fast charge led indicator.
- 5) Condition battery stage.
- 6) Charge complete on float.
- 7) Voltage displayed is volts out of product.
- 8) Scroll menu button.
- 9) Screen display showing a unit fault.

Remote control:
cut hole diameter
54mm

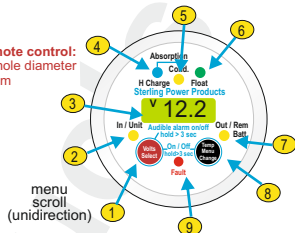

Volts Select Button (left)



Quick push = back light on.
Short press ~1 second = input voltage, press again for output voltage, press again for remote sense voltage.

Hold for 4 seconds to toggle between buzzer on/off, **bu2** should appear.

Both Left and Right buttons



Hold both buttons for 2 seconds to force to float **FtF**, toggle on / off.

Press and hold both buttons for 4 seconds to enter standby mode, **Stb** should appear. Repeat to turn unit on.

Press and hold both buttons for 6 seconds to turn unit off. **oFF** shall appear. Repeat to turn unit on.

Temp Menu Change (right button)



Quick press = back light on.
Short hold ~1 second = switch between unit's temperature and temperature sensor. If **nc** appear it means that the temperature sensor is not connected.

Hold for 2 seconds to toggle night mode on / off, **nn** should appear. 1/2 power for 8 hours.

Remote Error Codes

- E00** = high input voltage
- E01** = high output voltage
- E02** = high unit temp
- E03** = high batt. temp
- E04** = no output voltage

Setup - Menu:

to escape menu hold both buttons down until 'END' appears. Or, just leave the remote for 10 seconds.

Toggling is unidirectional

"**rt**" displays remaining absorption or conditioning time Press "select" button to see value.

"**btY**" displays battery profile type (0-9). This number denotes which charging profile the charger is set to. Press "select" to see value. (Ref: table labelled 'Battery Chemistry Selection' on).

"**coU**" displays input cut off voltage (the voltage at which the unit stops charging) (13.4V). Press "select" to see value.

"**loU**" display input / output base voltage (12/24V). Press "select". First input voltage will be displayed with "in" LED on for 3 sec. then output voltage with "out" LED on for 3 sec.

"**C/F**" change from celsius to fahrenheit or back* (default = celsius). Press "select" button to enter setting. Then press right button to change between Fahrenheit (FAH) and Celsius (CEL). Confirm setting by pressing "select" button.

"**CL**" set current limit to 1/2 or 1/1 (full). Press "select" button to see actual setting. Press "change" (right) button to change setting. Press "select" to confirm setting.

"**buC**" turn Buzzer on / off* (default = on). Press "select" to see actual setting. Press "change" button to change between settings. Press "select" again to confirm setting

"**Asc**" Autoscroll on / off (default = off). Press "select" to see actual setting. Press "change" button to change between settings. Press "select" again to confirm setting.

"**Von**" Voltage / temp display during standby and sleep. Toggle between on and off, press "select" (left) button to select.

"**con**" change contrast* value from 0 to 7 (default = 3). Press "select". First the lowest and the highest value will be displayed. Then the actual value. Press "change" button to change settings. Press "select" again to confirm setting.

"**bLc**" change backlight colour*. off <- auto -> green -> red -> blue (default = auto). Press "select" to see actual setting. Press "change" button to change between settings. Press "select" again to confirm setting.

"**bLt**" change backlight time*. 1 - 600 seconds, 0 = always on, (default = 60). Press "select". First the lowest and the highest value will be displayed. Then the actual value.

"**br9**" change remote display colour red to green voltage threshold.* 8.0V-13.3V (default 12.4V). When below 12.4V display is red and when 12.4V or above the remote goes green. When Press "select". First the lowest and the highest value will be displayed.

Then the actual value. Press "change" button to increase value. Hold "change" button to accelerate. When max. value reached it will start with lowest value. Press "select" again to confirm setting. Press "change" button to increase value. Hold "change" button to accelerate. When max. value reached it will start with lowest value. Press "select" again to confirm setting.

"**b9b**" change voltage from green to blue backlight* 12.4 - 16.0V (default 13.4V). Press "select". First the lowest and the highest value will be displayed. Then the actual value. Press "change" button to increase value. Hold "change" button to accelerate. When max. value reached it will start with lowest value. Press "select" again to confirm setting.

"**Led**" change LED on time 1 - 600 seconds, 0 = always on, (default = 60). Press "select". First the lowest and the highest value will be displayed. Then the actual value. Press "change" button to increase value. Hold "change" button to accelerate. When max. value reached it will start with lowest value. Press "select" again to confirm setting.

"**uid**" display Unit ID. Press "select". Value will be displayed for 5 sec.

"**uSW**" display unit software version. Press "select". Value will be displayed for 5 sec.

"**rSW**" display remote software version. Press "select". Value will be displayed for 5 sec.

"**Loc**" Unit lock code = 1 to 999 (default = 00 = unlocked).

WARNING This mode shall lock menu setting options of the unit by virtue of a pass code, be careful. Press "select" to enter "Loc" setting. Press "change" button to increase value, hold to accelerate. Stop when on the number you require and press "select" button to confirm. The software shall store this number, then the display shall read: **loc** -> on -> #. # = number you have stored. To remove **loc**, return to **loc** and re-enter the number, Press "select" button and the display should read: **loc** -> off (green back light). **Please make a note of this loc code here:** _____.

"**rSt**" Resets remote to default values*. Press "select". "NO" will be displayed. Press "change" to toggle between "YES" and "NO". Confirm by pressing "select". rSt will display if resetting.

"**rSu**" Resets the battery charger to default settings. Press "select". "NO" will be displayed. Press "change" to toggle between "YES" and "NO". Confirm by pressing "select". rSt will display if resetting.

► Fault Finding | Troubleshooting

Firstly, ensure the Pro Batt Ultra (BB) is wired up as per page 7. Ensure negatives are common and the BB charger's negative is connected to the starter battery's negative - avoid connecting to chassis negative. Voltages between common negatives should be ~0V.

Secondly, to test the BB, remove (or turn off) any secondary charging source like AC to DC battery chargers or solar chargers going to the battery banks. Leave the primary charger connected (alternator) - ensure alternator is working. We also recommend turning off any loads (inverters etc.).

How to test if the Pro Batt Ultra (BB) is charging:

With engine running (alternator charging), what is the voltage on the input terminal of the BB? What is the voltage on the output terminal of the BB? Measure these voltages at the BB's terminals, not at the batteries terminals.

Even though, by default, the BB can work down at 12.0V on the input; it still requires over 13.3V+ to turn on and get going. If you are getting alternator voltage at the input terminal (~14V) and 14V+ on the output terminal the chances are your BB is working fine. If little to no current is passing through the charger at these voltages then the batteries are either full or they are deceased. If the output voltage is between 13V-14V (but rising) then you could have a situation where the output batteries were very low in charge (or large in capacity) and the charger shall be charging at maximum current. Provided the voltage continues rising the BB is charging.

If your output voltage is less than 13V and your input voltage is healthy, it could be three things:

- 1) You have a large load on your output bank - turn load off.
- 2) The BB has been turned off - hold SETUP/ENTER + SELECT button for 5 seconds and let go, to turn on again.
- 3) The BB is not working.

If your input voltage is less than 13V, it could be several things:

Automotive: Your alternator's voltage is at less than 13V (the alt. is regenerative braking mode - sometimes expected on modern Euro 5/6+ engines) - take vehicle for drive and measure alternator's voltage and set up the BB to suit these needs. All vehicle manufactures have their own software / characteristics for regen. braking.

Automotive or Marine: If your alternator's voltage is ~14V then check continuity between the alternator's B+ terminal and the starter battery. If you are getting ~14V on starter battery then check continuity between starter battery and BB input terminal.

Automotive or Marine: If your alternator's voltage is 0-13V (starter battery voltage) then alternator may have failed. Or, requires increase rpm of engine, possible belt slip.

Is your output voltage slightly higher or lower than expected - even with no loads / chargers on?

Check if you have the temperature sensor connected. If so, no problems leaving it there, it is simply voltage compensating for when the temperature at the sensor is lower or higher than the benchmark 20DegC (69F). If lower, then the voltage shall rise and vice versa. The further from 20DegC in either direction leads to proportional increase or decrease in the voltage.

Possible, voltage drop across long cabling / fuse holder / diode. Use our remote sense connection on the unit - refer to page 6, yellow wire.

LED 16 flashing red - over voltage on input. This LED comes on if there is 19V for more than 3 seconds on the input terminal. Check the voltage at the input. Possible regulator fault, or alternative charger's voltage is too high.

LED 16 solid red - Over voltage output. There is 16V+ for more than 3 seconds on output terminal. Check the voltage at the output. Turn charger off, if voltage drops when off and rises again when turned on the possible charger fault. If 16V+ irrespective of charger being on then check alternative charging source.

LED 17 flashing red - over temperature. Unit has become too hot and switches off. Possible defective fan. Or, high ambient temperature, ensure good ventilation or the charger's vents may be blocked

LED 21 flashes yellow - high voltage drop across output cable. When the battery voltage sensor is connected the device has detected too high a voltage drop between the output and the positive terminal of the battery (>1.5V). Verify that the cable thickness is sufficient. Possibly the terminals are corroded or bad connection. Also check if the cable is actually connected to the battery.

LED 22 solid yellow or flashing - the charger is in 1/2 power. It has either been manually forced into 1/2 power mode or night mode (refer to page 9). Or, the charger has engaged 1/2 power mode itself due to the device's temperature (> 85°C). In this case, check the fan and the ambient temperature. Possibly the installation is not properly ventilated. Make the adequate ventilation.

LED 23 solid yellow or flashing - undervoltage. If the LED flashes, the input voltage is too low. Check the alternator or the charging source of the starter battery. If the LED is solid, the output voltage is very low - output batteries are likely to be defective.

LED 24 flashing red - high battery temperature. The unit has shut down due to excessive battery temperature (> 55°C). Either the battery is defective or the ambient temperature is too high. Provide adequate ventilation.

Customer Service & Warranty

Your 100 % satisfaction is our goal. We realise that every customer and circumstance is unique. If you have a problem, question, or comment please do not hesitate to contact us. We welcome you to contact us even after the warranty and return time has passed.

Product Warranty:

Each product manufactured by Sterling Power comes with at least a 2 year limited factory warranty. Certain Products have a warranty period of time greater than 2 years. Each product is guaranteed against defects in material or workmanship from the date of purchase. At our discretion, we will repair or replace free of charge any defects in material or workmanship that fall within the warranty period of the Sterling Power product. The following conditions do apply:

- **The original receipt or proof of purchase must be submitted to claim warranty. If proof cannot be located a warranty is calculated from the date of manufacture.**
- **Our warranty covers manufacture and material defects. Damages caused by abuse, neglect, accident, alterations and improper use are not covered under our warranty.**
- **Warranty is null and void if damage occurs due to negligent repairs.**
- **Customer is responsible for inbound shipping costs of the product to Sterling Power either in the USA or England.**
- **Sterling Power will ship the repaired or warranty replacement product back to the purchaser at their cost.**

If your order was damaged in transit or arrives with an error, please contact us ASAP so we may take care of the matter promptly and at no expense to you. This only applies for shipping which was undertaken by our company and does not apply for shipping organised by yourself. Please do not throw out any shipping or packaging materials.

All returns for any reason will require a proof of purchase with the purchase date. The proof of purchase must be sent with the returned shipment. If you have no proof of purchase call the vendor who supplied you and acquire the appropriate documentation.

To make a claim under warranty, call our customer care line at (USA 1-(207)-226-3500, England 01905 771771). We will make the best effort to repair or replace the product, if found to be defective within the terms of the warranty. Sterling Power will ship the repaired or warranty replacement product back to the purchaser, if purchased from us.

Please review the documentation included with your purchase. Our warranty only covers orders purchased from Sterling Power. We cannot accept warranty claims from any other Sterling Power distributor. Purchase or other acceptance of the product shall be on the condition and agreement that Sterling Power USA LLC and Sterling Power LTD shall not be liable for incidental or consequential damages of any kind. Some states may not allow the exclusion or limitation of consequential damages, so, the above limitations may not apply to you. Additionally, Sterling Power USA and Sterling Power LTD neither assumes nor authorizes any person for any obligation or liability in connection with the sale of this product. This warranty is made in lieu of all other obligations or liabilities. This warranty provides you specific legal rights and you may also have other rights, which vary from state to state. This warranty is in lieu of all other, expressed or implied.

Sterling Power Products Ltd
England
www.sterling-power.com

Sterling Power USA
Warranty Service Center
www.sterling-power-usa.com